

Determinants of renal oxygen metabolism during low Na⁺ diet: effect of angiotensin II AT₁ and aldosterone receptor blockade

Daniela Patinha^{1,2,*} , Carla Carvalho^{2,*}, Patrik Persson², Liselotte Pihl², Angelica Fasching², Malou Friederich-Persson², Julie O'Neill² and Fredrik Palm²

¹Institute of Biomedical and Clinical Science, University of Exeter Medical School, University of Exeter, Exeter, UK

²Department of Medical Cell Biology, Division of Integrative Physiology, Uppsala University, Uppsala, Sweden

Edited by: Peking Fong & Helle Praetorius

Linked articles: This article is highlighted in a Perspectives article by Heyman *et al.* To read this article, visit <https://doi.org/10.1113/JP280716>.

Key points

- Reducing Na⁺ intake reduces the partial pressure of oxygen in the renal cortex and activates the renin-angiotensin-aldosterone system.
- In the absence of high blood pressure, these consequences of dietary Na⁺ reduction may be detrimental for the kidney.
- In a normotensive animal experimental model, reducing Na⁺ intake for 2 weeks increased renal oxygen consumption, which was normalized by mineralocorticoid receptor blockade. Furthermore, blockade of the angiotensin II AT₁ receptor restored cortical partial pressure of oxygen by improving oxygen delivery.
- This shows that increased activity of the renin-angiotensin-aldosterone system contributes to increased oxygen metabolism in the kidney after 2 weeks of a low Na⁺ diet.
- The results provide insights into dietary Na⁺ restriction in the absence of high blood pressure, and its consequences for the kidney.

Abstract Reduced Na⁺ intake reduces the P_{O_2} (partial pressure of oxygen) in the renal cortex. Upon reduced Na⁺ intake, reabsorption along the nephron is adjusted with activation of the renin-angiotensin-aldosterone system (RAAS). Thus, we studied the effect of reduced Na⁺ intake on renal oxygen homeostasis and function in rats, and the impact of intrarenal angiotensin II AT₁ receptor blockade using candesartan and mineralocorticoid receptor blockade using canrenoic acid potassium salt (CAP). Male Sprague-Dawley rats were fed standard rat chow containing normal (0.25%) and low (0.025%) Na⁺ for 2 weeks. The animals were anaesthetized (thiobutabarbital 120 mg kg⁻¹) and surgically prepared for kidney oxygen metabolism and function studies before and after acute intrarenal arterial infusion of candesartan (4.2 μg kg⁻¹) or intravenous infusion of CAP (20 mg kg⁻¹). Baseline mean arterial pressure and renal blood

Daniela Patinha is a Postdoctoral Research Fellow at the University of Exeter. Her work has focused on identifying new therapeutic targets for kidney disease. More specifically, she is interested in oxygen metabolism by the kidney and its impact on the onset and progression of acute and chronic kidney disease, as well as its influence on blood pressure control. **Carla Carvalho** has a PhD in medical sciences from Uppsala University. Her research focused on oxygen handling by the kidney, with a special interest in renal mitochondrial function. She is currently a Senior Scientist at Truly Labs, Sweden.



*Both authors contributed equally to this study.

flow were similar in both dietary groups. Fractional Na^+ excretion and cortical oxygen tension were lower and renal oxygen consumption was higher in low Na^+ groups. Neither candesartan nor CAP affected arterial pressure. Renal blood flow and cortical oxygen tension increased in both groups after candesartan in the low Na^+ group. Fractional Na^+ excretion was increased and oxygen consumption reduced in the low Na^+ group after CAP. These results suggest that blockade of angiotensin II AT_1 receptors has a major impact upon oxygen delivery during normal and low Na^+ conditions, while aldosterone receptors mainly affect oxygen metabolism following 2 weeks of a low Na^+ diet.

(Received 6 July 2020; accepted after revision 26 August 2020; first published online 28 August 2020)

Corresponding author D. Patinha: Institute of Biomedical and Clinical Science, University of Exeter Medical School, Prince of Wales Rd, Exeter EX4 4PS, UK. Email: d.patinha@exeter.ac.uk

Introduction

As in other organs, renal oxygen content is determined by delivery and demand. Renal autoregulation maintains renal blood flow (RBF) within a wide range of perfusion pressures to maintain a stable glomerular filtration rate (GFR). However, since RBF is not under metabolic control, increasing renal metabolism can have a detrimental impact on tissue integrity if not matched by oxygen delivery. The partial pressure of oxygen (P_{O_2}) is heterogeneous in the renal parenchyma; it is relatively high in the highly perfused renal cortex and decreases towards the scarcely perfused inner renal medulla (Brezis *et al.* 1984, 1994b). Low P_{O_2} is a common observation in end stage renal disease, regardless of its aetiology (Hirakawa *et al.* 2017). We and others have shown that prolonged increased oxygen consumption (\dot{Q}_{O_2}), low P_{O_2} along the renal parenchyma and consequent renal hypoxia are associated with long-term renal impairment (Welch *et al.* 2001; Manotham *et al.* 2004; Matsumoto *et al.* 2004; Palm *et al.* 2004; Friederich-Persson *et al.* 2013; Ow *et al.* 2014; Franzen *et al.* 2016; Emans *et al.* 2018). In physiological conditions, the major determinant of renal oxygen metabolism is Na^+ transport (Brezis *et al.* 1994a). Increased kidney \dot{Q}_{O_2} can result from increased tubular Na^+ reabsorption to compensate for either glomerular hyperfiltration (Körner *et al.* 1994) or oxidative stress-induced reduction of electrolyte transport efficiency (Palm *et al.* 2003; Welch *et al.* 2003, 2005). The majority of Na^+ reabsorption occurs in the proximal tubule. Its permeable epithelium allows for paracellular ion flux driven by active Na^+ transport, resulting in a highly energy efficient process (Cohen, 1986; Pei *et al.* 2016). The downstream segments of the nephron have a tighter epithelium and account for refinement of Na^+ reabsorption with higher energy expenditure to conserve it (Cohen, 1986; O'Neill *et al.* 2015; Palmer & Schnermann, 2015; Layton *et al.* 2016; Pei *et al.* 2016). Consequently, increasing Na^+ reabsorption in downstream segments of the nephron may lead increased total kidney \dot{Q}_{O_2} .

While high Na^+ intake is associated with increased blood pressure and higher cardiovascular risk, there is a lack of evidence of the beneficial effects of Na^+ reduction in diet in normotensive conditions (Committee on the Consequences of Sodium Reduction in *et al.* 2013; Graudal *et al.* 2014; Kong *et al.* 2016; Lelli *et al.* 2018). Reducing Na^+ intake can reduce high blood pressure, thereby decreasing the risk of cardiovascular events and mortality. However, an association of low Na^+ diet with overall increased cardiovascular disease and mortality has been reported (Midgley *et al.* 1996; Stolarz-Skrzypek *et al.* 2011; Graudal *et al.* 2014; O'Donnell *et al.* 2014; Lelli *et al.* 2018). Low Na^+ intake results in compensatory activation of the renin-angiotensin-aldosterone system (RAAS) (Graudal *et al.* 1998; Shao *et al.* 2013) in proportion to the Na^+ reduction (Graudal *et al.* 1998). This can be detrimental for the kidney and would explain the relatively modest reductions in blood pressure observed after Na^+ restriction (Graudal *et al.* 1998). Accordingly, following 2 weeks of Na^+ restriction, renal angiotensin II is increased, resulting in both glomerular and tubulointerstitial fibrosis in rats (Shao *et al.* 2013). Activation of the RAAS affects both oxygen delivery and consumption in the kidney. Angiotensin II AT_1 receptor activation increases renal vascular tone, aldosterone production, Na^+ reabsorption mainly in the proximal tubule and reactive oxygen species (ROS) production (Onozato *et al.* 2002; Kobori *et al.* 2007; Banday & Lokhandwala, 2011; Patinha *et al.* 2013). In addition, aldosterone signalling through mineralocorticoid receptors increases Na^+ reabsorption in the distal tubule and collecting duct and contributes to ROS formation (Garty, 2000; Miyata *et al.* 2005; Udwan *et al.* 2017; Frindt *et al.* 2018). It would therefore be expected that reduced dietary Na^+ intake would increase kidney \dot{Q}_{O_2} due to elevated tubular sodium transport (T_{Na}) to maintain electrolyte balance, which potentially could result in intrarenal tissue hypoxia.

The pioneering work of Stillman *et al.* (1994) demonstrated that the tissue P_{O_2} gradient in the kidney was inverted. Following chronic administration of a Na^+

depleted diet, the P_{O_2} was higher in the renal medulla and lower in the cortical region (Stillman *et al.* 1994). This reversal of oxygen gradients may compromise kidney function and its long-term consequences are unknown. The mechanistic explanations of these alterations are presently undefined, but it may be speculated that the pronounced cortical hypoxia during Na⁺ restriction may be initiated by augmented RAAS signalling in the kidney. Prolonged exposure to increased RAAS could potentially explain the reported detrimental effects of reduced dietary Na⁺ intake (Stillman *et al.* 1994; Midgley *et al.* 1996; Graudal *et al.* 2014; O'Donnell *et al.* 2014). In the present study, we tested the hypothesis that low Na⁺ intake results in RAAS activation and a compensatory increase in tubular Na⁺ reabsorption. Furthermore, we hypothesized that low Na⁺ diet affects renal \dot{Q}_{O_2} as a consequence of increased RAAS signalling, resulting in altered oxygen availability.

Methods

Ethical approval

All experiments were performed in accordance with the European Convention for the Protection of Vertebrate Animals used for Experimental and other Scientific Purposes and approved by the local Animal Care and Use Committee (approval reference 5.8.18-13971/2018). Animals were housed in a temperature, humidity and light controlled environment (12 h light-dark cycle), had free access to water and were fed rat chow *ad libitum*. The investigators understand the ethical principles under which *The Journal of Physiology* operates and the present studies comply with its animal ethics checklist.

Animal model

Age matched (8–9 weeks old) male Sprague-Dawley rats (Charles River, Sulzfeldt, Germany) were fed either a normal (0.25%) or low (0.025%) Na⁺ diet (R36, Labfor, Stockholm, Sweden) for 2 weeks. Subsequently, the animals in each group were subjected to functional renal assessments under anaesthesia (see below) and further subdivided to yield four groups: normal Na⁺ diet with either intrarenal angiotensin II AT₁ receptor blockade using candesartan ($n = 13$) or mineralocorticoid receptor blockade using canrenoic acid potassium salt (CAP, $n = 11$) or low Na⁺ diet with either candesartan ($n = 12$) or CAP ($n = 9$).

Acute experimental protocol

The experimental protocol is depicted in Fig. 1. Rats were terminally anaesthetized with thiobutabarbital (Inactin,

120 mg kg⁻¹, i.p.), placed on a heating pad set at 37°C and tracheostomized. Catheters were placed into the left carotid artery and the left femoral artery and vein for blood pressure measurement, blood collection and saline infusion (Ringer solution, 5 ml kg⁻¹ h⁻¹), respectively. The bladder was catheterized for urinary drainage. The left kidney was exposed by a subcostal flank incision and immobilized in a plastic cup, as previously described (Patinha *et al.* 2013) and the left ureter was catheterized for urine collection. A catheter was advanced ~1–2 mm into the left renal artery, through a lumbar artery, for precise intrarenal infusion (a 10% solution of Lissamine Green was infused to confirm that catheter placement allowed precise intra-renal infusion with uniform distribution). After 45 min of stabilization, measurements were performed before and after drug infusion (Fig. 1). Candesartan (AstraZeneca, Mölndal, Sweden; 4.2 µg kg⁻¹ in 200 µl⁻¹), the angiotensin II AT₁ receptor blocker, was slowly infused over 10 min into the kidney via the renal artery, 10 min after the experimental period started, as previously detailed (Patinha *et al.* 2013). In another set of experiments, the aldosterone antagonist CAP (bolus 20 mg kg⁻¹ in 200 µl), was infused intravenously. At the end of the experiments animals were killed under anaesthesia by infusion of saturated potassium chloride or perfusion solution.

Measurements of kidney haemodynamics and oxygen metabolism

Blood pressure was measured using a transducer (model P23dB; Statham Laboratories, Los Angeles, CA, USA) connected to the left carotid artery catheter. Total RBF was measured using an ultrasound flow probe (Transonic Systems Inc., Ithaca, NY, USA) placed around the left renal artery. These parameters were continuously recorded with a Power Lab instrument (AD Instruments, Hastings, UK) connected to a Personal Computer. Glomerular filtration rate was estimated by inulin clearance ([³H]-inulin, American Radiolabeled Chemicals, St Louis, MO, USA; 185 kBq kg⁻¹ h⁻¹). Blood gas parameters were measured from samples drawn from the left femoral artery and left renal vein using the iSTAT System (Abbott Laboratories, Abbott Park, IL, USA). The left renal vein blood sample was collected using a heparinized syringe, in a slow manner to avoid sampling from the vena cava.

Urine volume was measured gravimetrically, and urinary Na⁺ concentration was quantified by flame spectrophotometry using a multianalyzer (model IL543; Instrumentation Lab, Milan, Italy). Protein concentrations were determined using DC Protein Assay according to manufacturer instructions (BioRad Laboratories, Hercules, CA, USA). Thiobarbituric acid reactive substances (TBARS) were measured

in urine and plasma samples. Briefly, 50 μl of standards (malondialdehyde-bis-(diethylacetate; Merck-Schuchardt, Schuchardt, Germany) and samples were heated with 62.5 μl of thiobarbituric acid (0.67%) at 97°C for 60 min. Samples were immediately cooled down on ice, precipitated with methanol/NaOH 1 mmol l⁻¹ (91:9) and centrifuged at 3000 rpm for 5 min at room temperature (RT). Fluorescence in the supernatant was determined (excitation 532 nm; emission 553 nm; Tecan Safire², Männedorf, Switzerland).

Kidney P_{O_2} was determined during the clearance period under anaesthesia using modified Clark-type oxygen microelectrodes with an outer diameter of the tip of less than 10 μm (Unisense, Aarhus, Denmark). Electrodes were two point calibrated in water saturated with either Na₂S₂O₅ ($P_{\text{O}_2} = 0$ mmHg) or air ($P_{\text{O}_2} = 147$ mmHg). The oxygen microelectrodes were positioned using a micromanipulator in order to measure the cortical and medullary P_{O_2} at 1 and 4 mm depths, respectively, from the kidney surface.

Tissue collection

Animals (additional normal Na⁺ diet $n = 10$; low Na⁺ diet $n = 10$) were anaesthetized as previously described and the kidneys extracted after ice-cold saline perfusion. The left kidney was collected for angiotensin II extraction and quantification and the right kidney was dissected and placed in RNA preserving solution (Ambion RNAlater, ThermoFisher Scientific, Waltham, MA, USA) or snap frozen with liquid nitrogen.

Angiotensin II extraction and quantification

Angiotensin II was extracted from the renal tissue as previously described (Fox *et al.* 1992). Briefly, the left kidney was removed, weighed, rapidly homogenized in cold methanol (10%, wt/vol) and stored at -80°C. Samples were thawed, centrifuged (10 min, 4°C) and dried overnight in a vacuum centrifuge before extraction. The dried residue was reconstituted in sodium phosphate buffer (50 mmol l⁻¹, pH 7.4) and applied to a phenyl-bounded solid phase extraction (SPE) column (Discovery DSC-Ph SPE Tube, Sigma Aldrich) previously conditioned with methanol and equilibrated with water. After washing, angiotensin II was eluted from the SPE column with 90% methanol in water and dried under vacuum. Angiotensin II was measured using an Angiotensin II EIA kit (Peninsula Laboratories Inc., San Carlos, CA, USA) according to the manufacturer's instructions.

RNA extraction, cDNA synthesis and quantification

The kidney cortex sections preserved in RNAlater were used for total RNA extraction using RNAqueous-4PCR (Ambion, Waltham, MA, USA). iScript cDNA Synthesis Kit (BioRad Laboratories) was used to synthesize cDNA from total RNA and levels were assessed by real time quantitative PCR using SYBR Green PCR reagent (Light-Cycler FastStart DNA Master SYBR Green I, Roche, Mannheim, Germany) and the iCycler PCR system (BioRad Laboratories) according to the manufacturer's instructions. Briefly, amplification reactions consisted of 2 μl cDNA, 2 μl Mix (LightCycler FastStart DNA Master

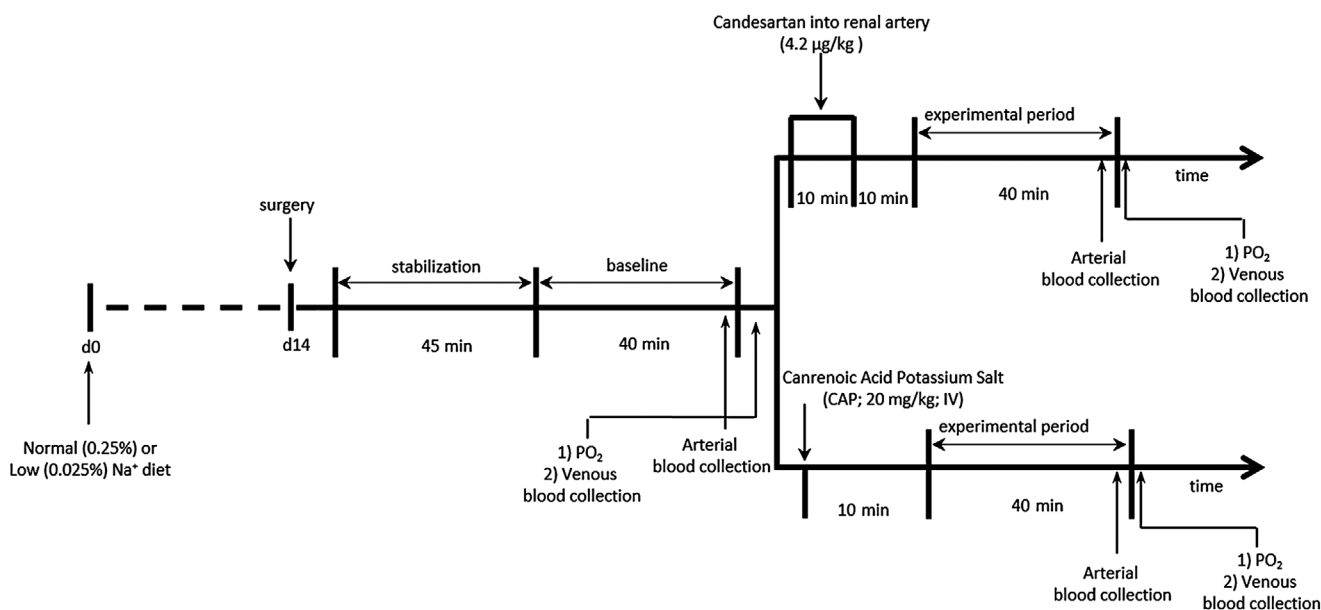

Figure 1. Schematic representation of the experimental protocol

Table 1. RT-PCR primer sequences

Gene	Sense (5'-3')	Antisense (5'-3')
Angiotensin II AT _{1A} receptor	TCCCTGAGTTAACATATGAGAG	TGTTTTCTGGGTTGAGTTG
Angiotensin II AT _{1B} receptor	CGGTGCATTTTAAATAGTGTC	AATATGTAATTGTGCCTGGC
β -actin	AAGACCTCTATGCCAACAC	TGATCTTCATGGTGCTAGG

SYBR Green I; Roche), 2.5 μ l primers mix and 3.5 μ l of H₂O. Relative gene expressions were calculated from $2^{-\Delta Ct}$ in relation to β -actin, which was used as the housekeeping gene. Primer sequences are detailed in Table 1.

Calculations

Renal vascular resistance was calculated as mean arterial pressure (MAP)/RBF. The filtration fraction (FF) was calculated using the formula $FF = GFR/(RBF \times (1 - \text{haematocrit}))$. *In vivo* kidney \dot{Q}_{O_2} was determined from the product of the arterio-venous difference in oxygen content (O_{2ct}) and RBF. Transported Na⁺ (T_{Na}) was calculated as $T_{Na} = [Na_p] \times GFR - [Na_U] \times \text{urine flow}$, where $[Na_p]$ and $[Na_U]$ are plasma and urine Na⁺ concentrations, respectively. Fractional Na⁺ excretion (FE_{Na}) was estimated from $[Na_U] \times [I_p]/[Na_p] \times [I_U]$, where $[I_p]$ and $[I_U]$ are plasma and urine Na⁺ and inulin concentrations, respectively.

All chemicals were from Sigma Aldrich and of highest grade available if not otherwise stated.

Statistical analysis

All statistical analyses were performed using Graph Pad Prism (GraphPad Software, San Diego, CA, USA). Differences between groups were assessed using two-way ANOVA followed by an uncorrected Fisher's LSD test. Differences in angiotensin II concentration and mRNA expression of angiotensin II AT_{1a} and AT_{1b} receptors were assessed using Student's unpaired *t* test. For all comparisons, $P < 0.05$ was considered statistically significant. Descriptive statistics are presented as means \pm SD.

Results

Effect of Na⁺ diet

Increased RAAS activity in the low Na⁺ group was confirmed by increased intrarenal tissue concentrations of angiotensin II (Table 2). In the kidney cortex, mRNA expression of angiotensin II receptor AT_{1a} was decreased while no alteration was observed in AT_{1b} (Table 2). Body weight (396 \pm 8 vs. 396 \pm 9 g; NS) and kidney weight (1.28 \pm 0.04 vs. 1.27 \pm 0.03 g; NS) were similar between

Table 2. Intrarenal tissue angiotensin II concentration (n = 5) and relative mRNA expression of angiotensin II AT_{1a} (n = 6–9) and AT_{1b} (n = 5–6) receptors, in kidney cortex

	Normal Na ⁺	Low Na ⁺
Angiotensin II (fmol g ⁻¹)	22.0 \pm 6.7	32.8 \pm 8.0*
AT _{1a} (RT expression/ β -actin)	1.07 \pm 0.43	0.41 \pm 0.14*
AT _{1b} (RT expression/ β -actin)	1.08 \pm 0.50	2.03 \pm 1.12

Results expressed as means \pm SD.

* $P < 0.05$ versus normal Na⁺. Differences between groups were assessed using Student's unpaired *t* test.

normal and low Na⁺ groups. Likewise, no difference was observed in MAP and RBF (Figs 2 and 6), GFR, FF, FE_K and arterial gas status (Tables 3 and 4) between normal and low Na⁺ groups at baseline. Arterial blood electrolytes, haemoglobin, haematocrit and pH, TBARS and protein excretion, and plasma TBARS were also similar at baseline between normal and low Na⁺ groups (Tables 3 and 4). Oxygen delivery (Figs 3A and 7A) was similar between normal and low Na⁺ groups at baseline; however, \dot{Q}_{O_2} (Figs 3B and 7B) and fractional O₂ extraction (Figs 3C and 7C) were more than 50% higher in the low Na⁺ group when compared with the normal Na⁺ group at baseline. T_{Na} (Figs 4B and 8B) was unaltered, while FE_{Na} (Figs 4A and 8A) and T_{Na}/\dot{Q}_{O_2} (Figs 4C and 8C) were more than 30% lower in the low Na⁺ groups. This coincided with more than 14% lower cortical (Figs 5A and 9A) and more than 25% higher medullary P_{O_2} (Figs 5B and 9B) in the low Na⁺ groups at baseline compared with normal Na⁺ groups at baseline.

Contribution of RAAS – effect of angiotensin II AT₁ receptor blockade

Candesartan was used to block angiotensin II AT₁ receptors; infusion of candesartan directly into the left kidney via the renal artery did not alter MAP (Fig. 2A), GFR, arterial blood gas status, electrolytes, haemoglobin, haematocrit or pH (Table 3) in either dietary group. Intrarenal infusion of candesartan decreased FF in the normal Na⁺ group but was without significant effect on this variable in the low Na⁺ group (Table 3). Following candesartan infusion, FE_K and TBARS excretion were increased in the low Na⁺ group but the blocker

Table 3. Glomerular filtration rate, filtration fraction, urinary electrolyte handling parameters and arterial blood gas status in animals fed a normal ($n = 12$ -13) or low ($n = 12$) Na^+ diet during baseline and after candesartan

	Normal Na^+		Low Na^+	
	Baseline	Candesartan	Baseline	Candesartan
GFR (ml min^{-1})	1.3 ± 0.6	1.2 ± 0.4	1.1 ± 0.4	1.3 ± 0.3
FF (%)	23.1 ± 12.1	$13.6 \pm 5.0^*$	17.0 ± 9.1	15.3 ± 4.5
FE_K (%)	33.4 ± 12.2	43.6 ± 16.9	22.8 ± 10.6	$51.5 \pm 14.3^* \#$
Urinary TBARS (pmol h^{-1})	0.18 ± 0.19	0.22 ± 0.27	0.41 ± 0.34	$0.81 \pm 0.55^* \#$
Urinary protein (mg h^{-1})	2.7 ± 0.6	$4.1 \pm 1.4^*$	3.0 ± 0.8	$4.5 \pm 1.7^*$
Plasma Na^+ (mmol l^{-1})	138.8 ± 1.6	140.2 ± 2.2	140.0 ± 1.7	140.3 ± 2.2
Plasma K^+ (mmol l^{-1})	4.6 ± 0.3	$4.0 \pm 0.3\#$	$5.1 \pm 0.8^*$	$4.1 \pm 0.2\#$
Haemoglobin (g l^{-1})	151 ± 8	150 ± 6	151 ± 7	147 ± 7
Haematocrit (%)	45 ± 2	44 ± 2	44 ± 2	43 ± 2
Blood pH	7.40 ± 0.02	$7.42 \pm 0.02^*$	7.39 ± 0.03	$7.41 \pm 0.03\#$
Blood P_{O_2} (mmHg)	70 ± 5	70 ± 4	74 ± 8	70 ± 6
Blood P_{CO_2} (mmHg)	50 ± 4	$46 \pm 4^*$	48 ± 4	$44 \pm 3\#$
Plasma TBARS (nmol l^{-1})	4.1 ± 1.3	6.4 ± 7.6	3.1 ± 1.7	3.3 ± 1.7

Abbreviations: FF, filtration fraction; FE_K , fractional urinary excretion of K^+ ; GFR, glomerular filtration rate; P_{O_2} , partial pressure of O_2 ; P_{CO_2} , partial pressure of CO_2 . Results expressed as means \pm SD.

* $P < 0.05$ versus baseline normal Na^+ ;

$P < 0.05$ versus baseline low Na^+ . Differences between groups were assessed using two-way ANOVA followed by an uncorrected Fisher's LSD test.

was without significant effect on these variables in the normal Na^+ group (Table 3). After candesartan infusion, proteinuria was increased in both groups (Table 3). RBF (Fig. 2B) and renal oxygen delivery (Fig. 3A) increased by more than 35% in both normal and low Na^+ groups following intrarenal candesartan infusion. \dot{Q}_{O_2} (Fig. 3B) and fractional oxygen extraction (Fig. 3C) were more than doubled following candesartan infusion in the normal

Na^+ group, but no significant alteration was seen in the low Na^+ group. Intrarenal candesartan infusion more than doubled FE_{Na} in both normal and low Na^+ groups (Fig. 4A). T_{Na} (Fig. 4B) was not significantly altered following candesartan infusion in both groups, and $T_{\text{Na}}/\dot{Q}_{\text{O}_2}$ (Fig. 4C) was decreased more than 40% following candesartan infusion in the normal Na^+ group, but was not significantly affected in the low Na^+ group. Following

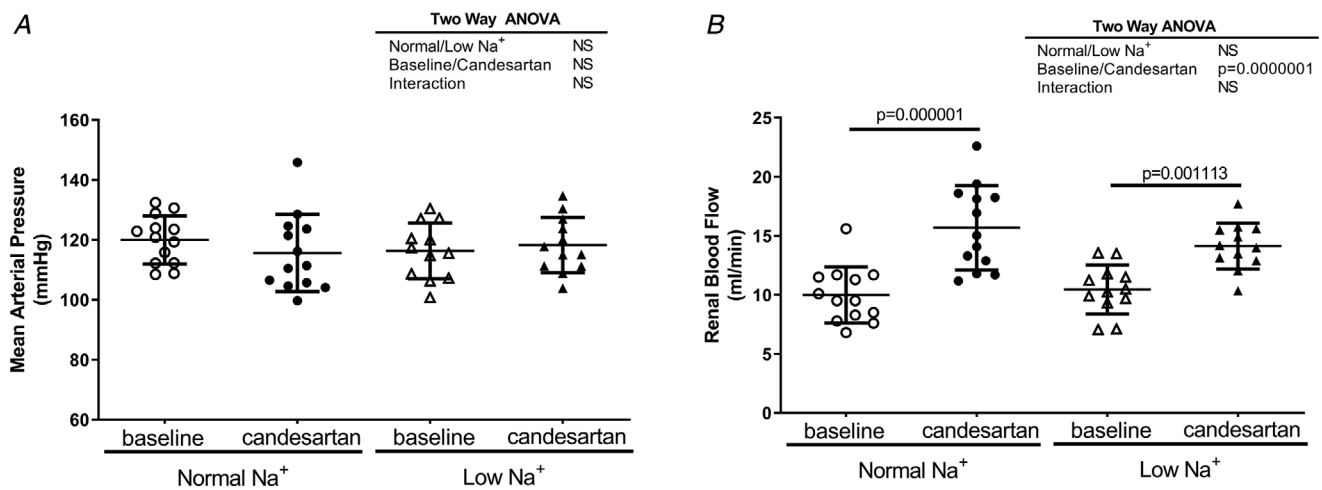

Figure 2. Intrarenal angiotensin II AT_1 receptor blockade increases renal blood flow similarly in both Na^+ diets independently of blood pressure

Mean arterial pressure (A) and renal blood flow (B) in healthy animals fed a normal ($n = 13$) or low ($n = 12$) Na^+ diet, before (baseline) and after angiotensin II AT_1 receptor blockade using candesartan ($4.2 \mu\text{g kg}^{-1}$). Results expressed as means \pm SD. $P < 0.05$ was considered statistically significant. Differences between groups were assessed using two-way ANOVA followed by an uncorrected Fisher's LSD test.

Table 4. Glomerular filtration rate, filtration fraction, urinary electrolyte handling parameters and arterial blood gas status in animals fed a normal or low Na⁺ diet during baseline and after CAP

	Normal Na ⁺		Low Na ⁺	
	Baseline	CAP	Baseline	CAP
GFR (ml min ⁻¹)	1.2 ± 0.4	1.4 ± 0.4	1.0 ± 0.4	1.0 ± 0.4
FF (%)	28.8 ± 10.1	29.8 ± 12.7	24.8 ± 6.7	20.5 ± 6.9
FE _K (%)	18.7 ± 14.8	35.3 ± 31.3	15.4 ± 13.0	44.2 ± 28.9* #
Urinary TBARS (pmol h ⁻¹)	0.35 ± 0.17	0.61 ± 0.32	0.65 ± 0.47	0.78 ± 0.59*
Urinary protein (mg h ⁻¹)	2.21 ± 0.97	2.14 ± 0.91	2.54 ± 0.71	2.27 ± 0.75
Plasma Na ⁺ (mmol l ⁻¹)	137.8 ± 0.8	138.7 ± 2.6	137.4 ± 1.8	138.3 ± 1.7
Plasma K ⁺ (mmol l ⁻¹)	4.4 ± 0.3	4.5 ± 0.3	4.9 ± 0.4*	4.8 ± 0.5
Haemoglobin (g l ⁻¹)	148 ± 13	145 ± 9	154 ± 11	147 ± 12
Haematocrit (%)	44 ± 4	43 ± 3	45 ± 3	43 ± 4
Blood pH	7.40 ± 0.03	7.42 ± 0.03	7.40 ± 0.02	7.41 ± 0.01
Blood P _{O₂} (mmHg)	66 ± 4	70 ± 6	69 ± 4	71 ± 7*
Blood P _{CO₂} (mmHg)	53 ± 4	49 ± 2*	49 ± 4*	46 ± 2*
Plasma TBARS (nmol l ⁻¹)	2.64 ± 0.74	2.14 ± 0.55	2.28 ± 0.32	2.21 ± 0.44

Abbreviations: FF, filtration fraction; FE_K, fractional urinary excretion of K⁺; GFR, glomerular filtration rate; P_{O₂}, partial pressure of O₂; P_{CO₂}, partial pressure of CO₂. Results expressed as means ± SD.

**P* < 0.05 versus baseline normal Na⁺;

#*P* < 0.05 versus baseline low Na⁺. Differences between groups were assessed using two-way ANOVA followed by an uncorrected Fisher's LSD test.

candesartan infusion, P_{O₂} in the renal cortex of the low Na⁺ group significantly increased to levels comparable with the normal Na⁺ group at baseline, but renal medulla P_{O₂} remained unchanged (Fig. 5A and B).

Contribution of RAAS – effect of aldosterone mineralocorticoid receptor blockade

CAP was used to block aldosterone receptors. Following CAP infusion, no effect was observed on MAP, RBF (Fig. 6), GFR or FF (Table 4) in either dietary group when compared with baseline levels. Similarly, arterial blood gas status, electrolytes, haemoglobin, haematocrit or pH (Table 4) remained unaltered following CAP infusion in normal and low Na⁺ groups. Interestingly, FE_K was increased by approximately 7-fold after CAP in the low Na⁺ group, with no significant alteration observed in the normal Na⁺ group (Table 4). Urinary TBARS and protein excretion and plasma TBARS were not altered after CAP infusion in both groups. After CAP infusion no significant alteration was observed in oxygen delivery (Fig. 7A) in either group; However, \dot{Q}_{O_2} (Fig. 7B) was reduced by 37% in the low Na⁺ group to levels that were comparable with the normal Na⁺ group at baseline. Fractional oxygen extraction (Fig. 7C) was significantly reduced by 42% only in the low Na⁺ group. Following CAP infusion, no alteration was observed in FE_{Na} (Fig. 8A) in the normal Na⁺ group, but it increased FE_{Na} to levels that were comparable with the normal Na⁺ group at baseline. No effect was observed on transported Na⁺ (Fig. 8B) or

T_{Na}/\dot{Q}_{O_2} in both groups after CAP. Finally, no significant effect was observed on tissue P_{O₂} in the cortex and medulla following CAP infusion in both normal and low Na⁺ groups (Fig. 8).

Discussion

The main novel finding of the present study was that reducing Na⁺ intake for 2 weeks to the extent that intrarenal angiotensin II was increased, in normotensive conditions, increased renal \dot{Q}_{O_2} , which was completely normalized by mineralocorticoid receptor blockade. Furthermore, acute blockade of angiotensin II AT₁ receptors restored cortical P_{O₂} by improving oxygen delivery. Overall, these data suggest that heightened aldosterone signalling promotes an increase in renal \dot{Q}_{O_2} in the low Na⁺ group. Interestingly, the normalization of cortical P_{O₂} in the low Na⁺ group was only achieved during intrarenal angiotensin II AT₁ receptor blockade. This was mediated through an increase in oxygen delivery as opposed to alteration of renal \dot{Q}_{O_2} , indicating that increased oxygen delivery regulation of renal P_{O₂} supersedes metabolic demand in this context.

Urinary Na⁺ excretion is continuously adjusted to match intake, thus preserving osmotic balance. Accordingly, in the present study, normal and low Na⁺ groups had similar plasma electrolyte concentration, MAP, RBF and GFR, but the low Na⁺ group had lower FE_{Na}, indicating that adjustment to low Na⁺ intake occurred mainly within the tubular segments. The otherwise healthy

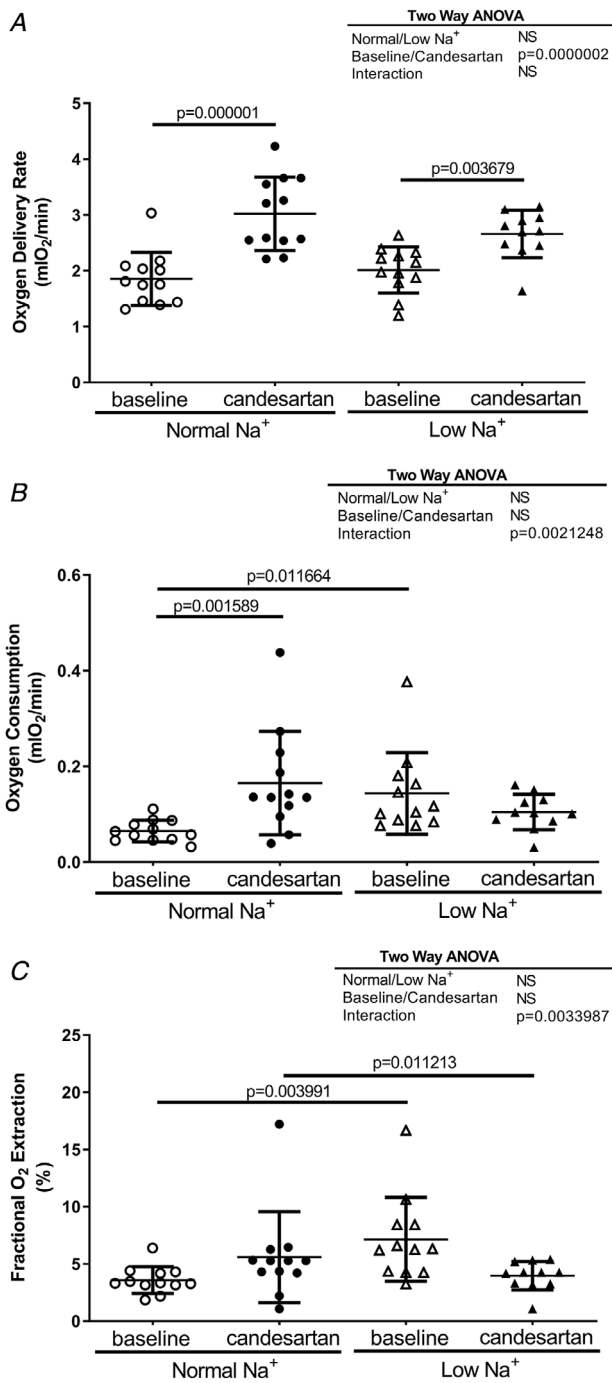

Figure 3. Low Na⁺ diet-induced increase in renal QO₂ is maintained after intrarenal angiotensin II AT₁ receptor blockade

Oxygen delivery rate (A), oxygen consumption (B) and fractional oxygen extraction (C) in healthy animals fed a normal ($n = 12$) or low ($n = 11-12$) Na⁺ diet, before (baseline) and after angiotensin II AT₁ receptor blockade using candesartan ($4.2 \mu\text{g kg}^{-1}$). Results expressed as means \pm SD. $P < 0.05$ was considered statistically significant. Differences between groups were assessed using two-way ANOVA followed by an uncorrected Fisher's LSD test.

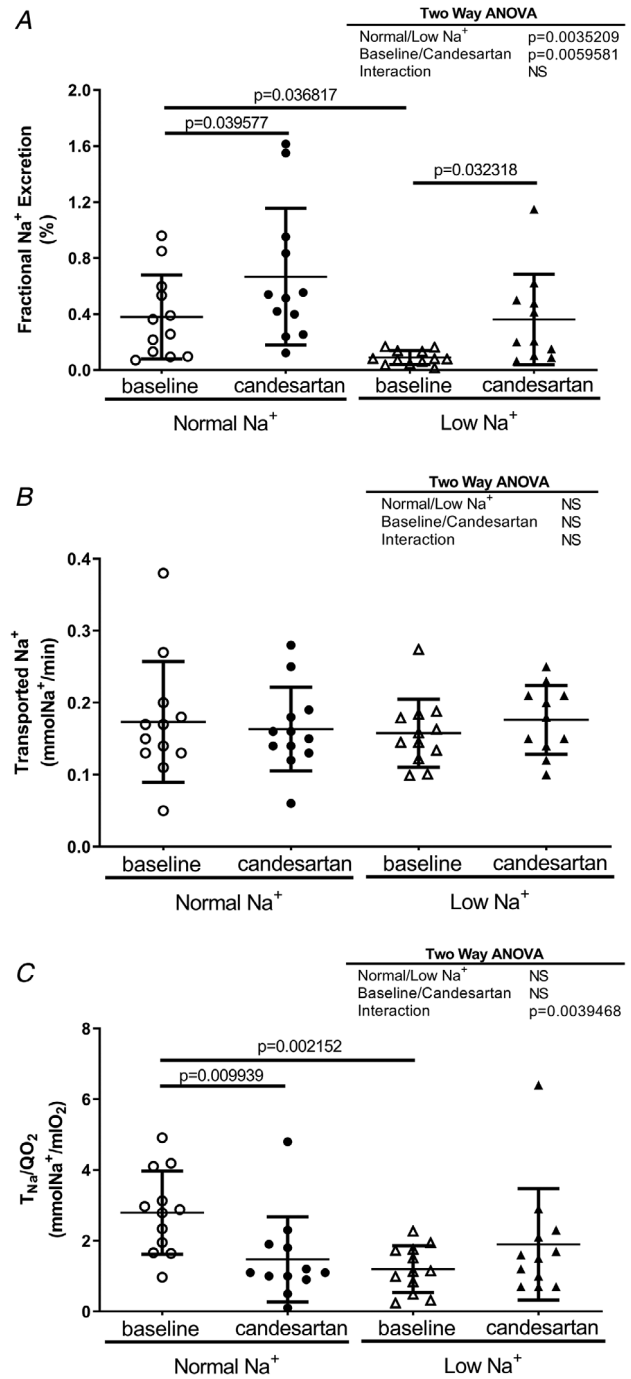

Figure 4. Low Na⁺ diet-induced decrease in renal TNa/QO₂ is maintained after intrarenal angiotensin II AT₁ receptor blockade, despite the increase in FNa⁺

Fractional Na⁺ excretion (A), transported Na⁺ (T_{Na}) (B) and $T_{\text{Na}}/\dot{Q}_{\text{O}_2}$ (C) in healthy animals fed a normal ($n = 12$) or low ($n = 11-12$) Na⁺ diet, before (baseline) and after angiotensin II AT₁ receptor blockade using candesartan ($4.2 \mu\text{g kg}^{-1}$). Results expressed as means \pm SD. $P < 0.05$ was considered statistically significant. Differences between groups were assessed using two-way ANOVA followed by an uncorrected Fisher's LSD test.

kidneys of animals in the low Na⁺ group exhibited altered oxygen homeostasis with increased \dot{Q}_{O_2} and decreased Na⁺ transport efficiency. This is possibly associated with a redistribution of Na⁺ reabsorption along the tubule (Udwan *et al.* 2017; Frindt *et al.* 2018), and consequent increase workload in less efficient segments of the nephron where the epithelia is tighter and the energy demand is higher when compared with the proximal tubule (Cohen, 1986; Palmer & Schnermann, 2015; Layton *et al.* 2016). Indeed, during a low Na⁺ diet, Na⁺ reabsorption is increased not only in the proximal tubule but also in the distal tubule/connecting tubule and collecting duct (Udwan *et al.* 2017; Frindt *et al.* 2018).

The observed increase in renal \dot{Q}_{O_2} may have long-term detrimental effects. Friederich-Persson showed that increasing kidney metabolism by increasing mitochondrial \dot{Q}_{O_2} leads to tubulointerstitial damage, proteinuria and infiltration of inflammatory cells (Friederich-Persson *et al.* 2013). Also, low renal P_{O_2} precedes oxidative stress and proteinuria in diabetic mice (Franzen *et al.* 2016). Likewise, reduced cortical P_{O_2} precedes renal injury in angiotensin II-dependent hypertension (Emans *et al.* 2016), indicating that the presently observed increased \dot{Q}_{O_2} and reduced cortical P_{O_2} induced by a low Na⁺ diet may lead to renal injury. Accordingly, tubulointerstitial fibrosis (Shao *et al.* 2013)

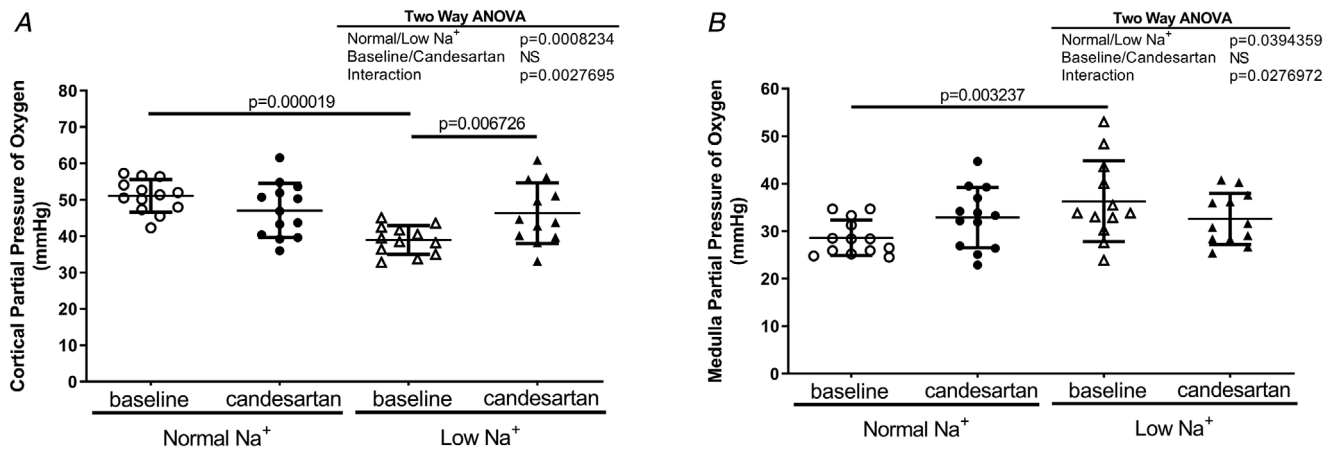

Figure 5. Low Na⁺ diet induced decrease in cortical PO₂ is restored after intrarenal angiotensin II AT₁ receptor blockade

Cortical (A) and medullary (B) partial pressure of oxygen in healthy animals fed a normal ($n = 13$) or low ($n = 12$) Na⁺ diet, before (baseline) and after angiotensin II AT₁ receptor blockade using candesartan ($4.2 \mu\text{g kg}^{-1}$). Results expressed as means \pm SD. $P < 0.05$ was considered statistically significant. Differences between groups were assessed using two-way ANOVA followed by an uncorrected Fisher's LSD test.

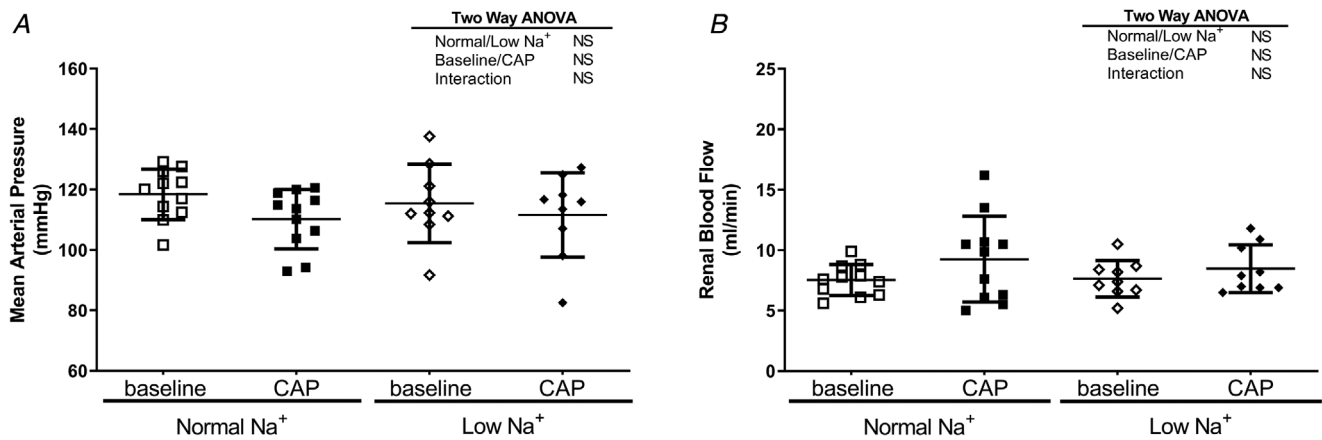

Figure 6. Blood pressure and renal blood flow are unaffected after aldosterone mineralocorticoid receptor blockade in both Na⁺ diets

Mean arterial pressure (A) and renal blood flow (B) in healthy animals fed a normal ($n = 11$) or low ($n = 9$) Na⁺ diet, before (baseline) and after aldosterone mineralocorticoid receptor blockade using CAP (20 mg kg^{-1}). Results expressed as mean \pm SD. $P < 0.05$ was considered statistically significant. Differences between groups were assessed using two-way ANOVA followed by uncorrected Fisher's LSD test.

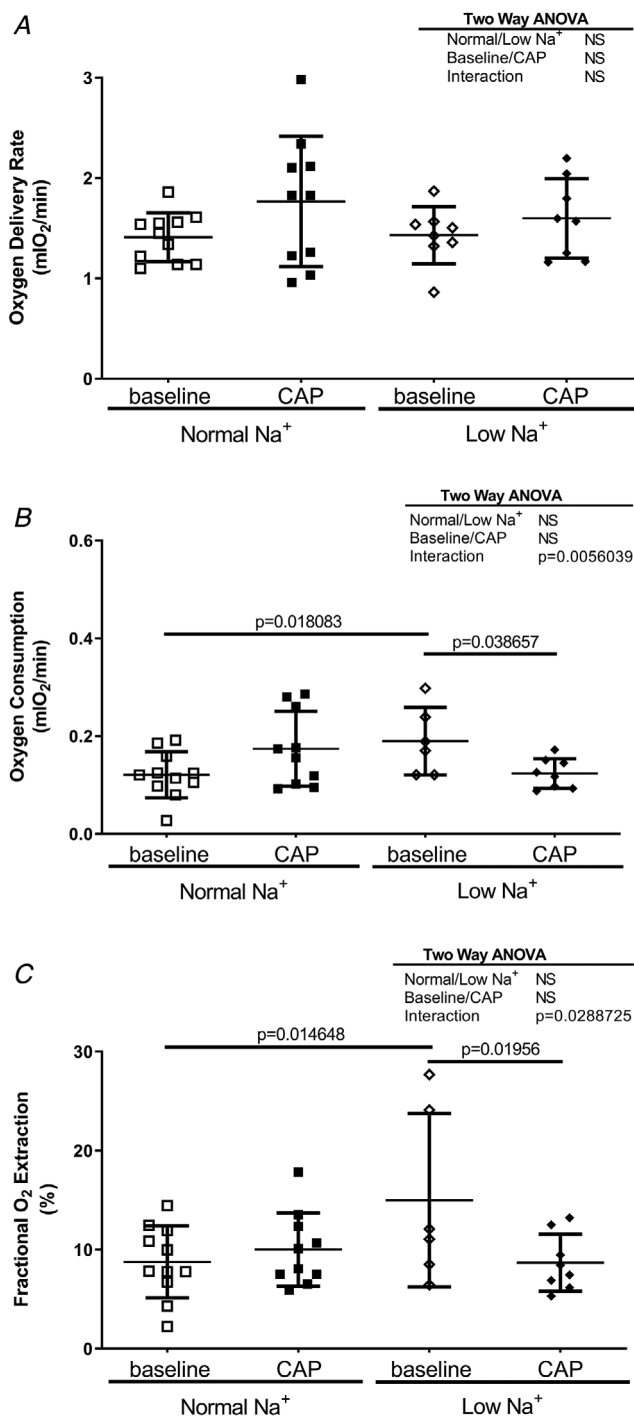

Figure 7. Low Na⁺ diet-induced increase in renal QO₂ is restored by aldosterone mineralocorticoid receptor blockade Oxygen delivery rate (A), oxygen consumption (B) and fractional oxygen extraction (C) in healthy animals fed a normal ($n = 10-11$) or low ($n = 6-8$) Na⁺ diet, before (baseline) and after aldosterone mineralocorticoid receptor blockade using CAP (20 mg kg⁻¹). Results expressed as means \pm SD. $P < 0.05$ was considered statistically significant. Differences between groups were assessed using two-way ANOVA followed by an uncorrected Fisher's LSD test.

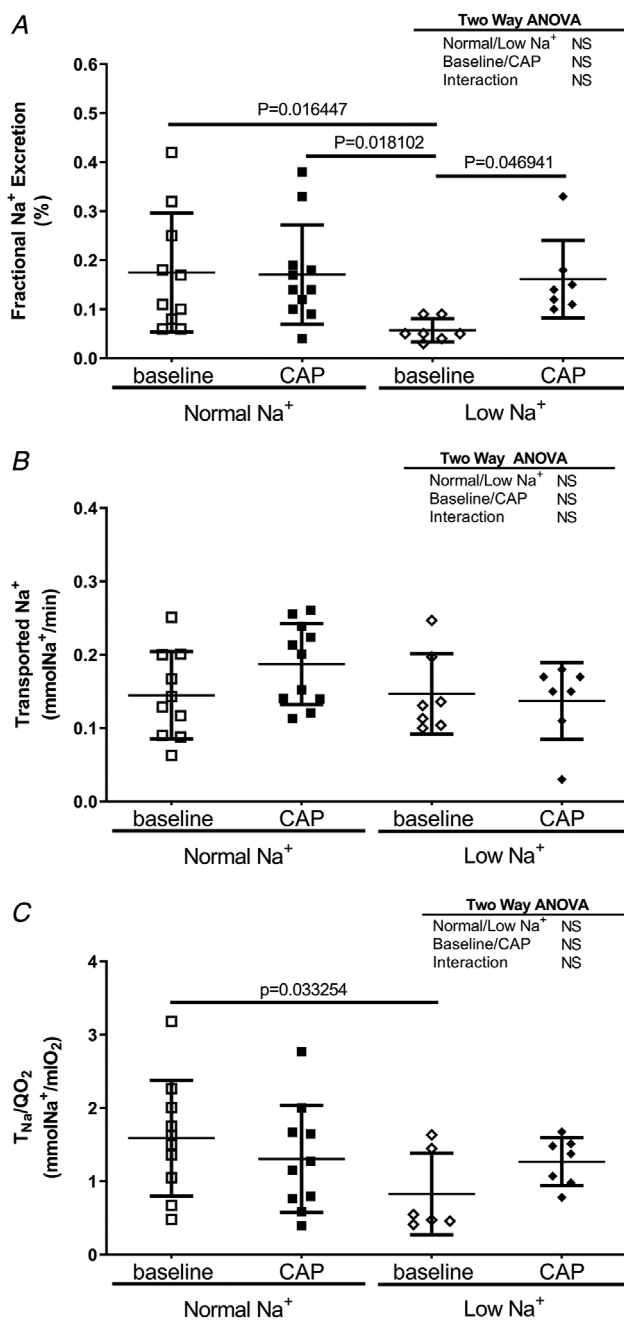

Figure 8. Low Na⁺ diet-induced decrease in renal TNa⁺/QO₂ is maintained after aldosterone mineralocorticoid receptor blockade, despite the increase in FNa⁺

Fractional Na⁺ excretion (A), transported Na⁺ (T_{Na^+}) (B) and T_{Na^+}/Q_{O_2} (C) in healthy animals fed a normal ($n = 10-11$) or low ($n = 6-7$) Na⁺ diet, before (baseline) and after aldosterone mineralocorticoid receptor blockade using CAP (20 mg kg⁻¹). Results expressed as means \pm SD. $P < 0.05$ was considered statistically significant. Differences between groups were assessed using two-way ANOVA followed by an uncorrected Fisher's LSD test.

and proteinuria have been documented in healthy animals fed a low Na⁺ diet for 2 weeks. Furthermore, cortical hypoxia measured using BOLD-MRI was reported to be a prognostic marker in the progression of chronic kidney disease (Zhou *et al.* 2018). In agreement with the previous report by Stillman *et al.* (1994), we also observed increased medullary P_{O_2} in the Na⁺ restricted animals. We can only speculate that increased proximal Na⁺ reabsorption reduced medullary tubular Na⁺ load, resulting in a reduced amount of active reabsorption by the medullary nephron segments. Indeed, reduced Na⁺ intake for 4 weeks significantly reduces medullary thick ascending limb size (Stillman *et al.* 1994), possibly indicating a reduced workload in this part of the segment. This would imply that reduced Na⁺ intake reduces the metabolic activity in the renal medulla and therefore also reduces \dot{Q}_{O_2} and increases P_{O_2} in this region of the kidney. On the other hand, the increased reabsorption in cortical nephron segments would increase \dot{Q}_{O_2} and cause hypoxia. It has also been shown in normotensive humans with reduced Na⁺ intake that the increased medullary oxygenation is due to enhanced proximal tubular Na⁺ reabsorption, resulting in reduced Na⁺ delivery to and workload in the distal, less efficient, tubular segments (Pruijm *et al.* 2010). These alterations could mechanistically explain the abolished cortico-medullary P_{O_2} gradient during reduced Na⁺ intake.

A low Na⁺ diet increases intrarenal activity of the RAAS (Schmid *et al.* 1997; Graudal *et al.* 1998; Shao *et al.* 2013), confirmed in the present study by an increased tissue angiotensin II concentration in the low Na⁺ group. The low Na⁺ diet decreased AT_{1a} receptor expression but did not affect AT_{1b} receptor expression, and this differential

regulation is in good agreement with previously reported data (Schmid *et al.* 1997). The AT_{1a} receptor is critical for Na⁺ handling and blood pressure control (Chen *et al.* 1997; Oliverio *et al.* 2000), its downregulation may be important to prevent blood pressure increases in the context of high angiotensin II, while the AT_{1b} receptors may be more relevant for Na⁺ conservation in low Na⁺ conditions. Indeed, during low Na⁺, AT_{1b} receptors mediate RAAS-dependent stimulation of aldosterone production in the adrenal gland (Kitami *et al.* 1992; Schmid *et al.* 1997). The angiotensin (1-7)/Mas receptor axis may also be an important contributor for Na⁺ balance in low Na⁺ conditions. Indeed, the diuretic and natriuretic actions of angiotensin 1-7 are enhanced following a low Na⁺ diet, although the blockade of the Mas receptor had no effect on basal Na⁺ excretion (O'Neill *et al.* 2013, 2017). Rearrangements of Na⁺ reabsorption along the tubule during a low Na⁺ diet are mainly attributed to proximal tubule, late distal tubule/connecting tubule and collecting duct adaptations (Udwan *et al.* 2017; Frindt *et al.* 2018). In these tubular segments, NHE₃ and epithelial Na⁺ channel (ENaC) are major transporters (Palmer & Schnermann, 2015) and under strict regulation by the RAAS (Geibel *et al.* 1990; Garty, 2000; Peti-Peterdi *et al.* 2002; Banday & Lokhandwala, 2011). We therefore tested the effect of angiotensin II AT₁ and aldosterone mineralocorticoid receptor blockade on oxygen metabolism after 2 weeks of a low Na⁺ diet.

Mean arterial pressure remained stable in both groups after angiotensin II AT₁ receptor blockade, confirming that candesartan infusion into the kidney was accurate and that the observed effects were blood pressure independent. RBF and oxygen delivery were increased

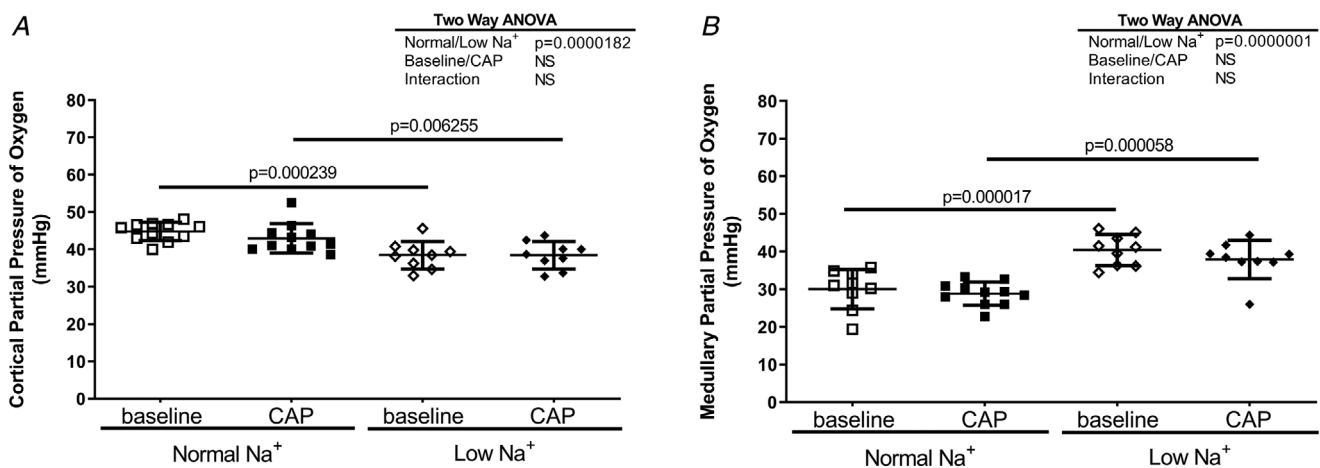

Figure 9. Low Na⁺ diet-induced reverse of renal PO₂ gradients is maintained after aldosterone mineralocorticoid receptor blockade

Cortical (A) and medullary (B) partial pressure of oxygen in healthy animals fed a normal ($n = 9-11$) or low ($n = 9$) Na⁺ diet, before (baseline) and after aldosterone mineralocorticoid receptor blockade using CAP (20 mg kg⁻¹). Results expressed as means \pm SD. $P < 0.05$ was considered statistically significant. Differences between groups were assessed using two-way ANOVA followed by an uncorrected Fisher's LSD test.

to a similar extent and GFR unaltered after angiotensin II AT₁ receptor blockade in both groups. Intriguingly, in the normal Na⁺ group this was accompanied by an increase in \dot{Q}_{O_2} , while no alteration was observed in the low Na⁺ group. Also, FE_{Na} was increased in both groups. Angiotensin II AT₁ receptor activation directly influences Na⁺ reabsorption namely by (1) stimulation the Na⁺/K⁺ ATPase pump in the basolateral membrane (Yingst *et al.* 2004); (2) stimulation Na⁺/H⁺ exchange in the luminal membrane, mainly by activating NHE₃ in the proximal tubule (Geibel *et al.* 1990); and (3) Na⁺/HCO₃⁻ co-transport in the basolateral membrane (Geibel *et al.* 1990). Additionally, the vasoconstrictor effect on efferent arteriole reduces the blood flow to peritubular capillaries thus increasing Na⁺ net reabsorption, especially in the proximal tubule. Hence, we propose that angiotensin II AT₁ receptor blockade mainly affected Na⁺ reabsorption in the proximal region of the tubule of the normal Na⁺ group, promoting higher downstream delivery where Na⁺ reabsorption is less effective. This premise is in line with the effect of inhibiting angiotensin converting enzyme, which rapidly reduced Na⁺ reabsorption in the proximal tubule mainly by reducing NHE₃, without altering blood pressure or GFR (Leong *et al.* 2006). Our findings also in part corroborate the mathematical modelling predictions of NHE₃ inhibition resulting in lower Na⁺ transport efficiency in the otherwise healthy kidney of rats (Layton *et al.* 2016). The effect of angiotensin II AT₁ receptor activation on the stimulation Na⁺ reabsorption in the cortical collecting duct via ENaC (Peti-Peterdi *et al.* 2002) may also contribute, to a smaller extent, to the observed effects. The present results refer to the whole kidney, but one cannot exclude the possibility that there might be heterogeneity in these parameters at the nephron level (Källskog *et al.* 1976; Inscho *et al.* 1997).

The lack of effect of angiotensin II AT₁ receptor blockade on \dot{Q}_{O_2} in the low Na⁺ group may also be an extension of the previously stated premise. In the low Na⁺ group, the downstream Na⁺ reabsorption was already altered at baseline (Udwan *et al.* 2017; Frindt *et al.* 2018), with increased \dot{Q}_{O_2} and lower tubular transport efficiency, as presently observed, indicating that the angiotensin II AT₁ receptor is not the only contributor to the overall increased \dot{Q}_{O_2} in low Na⁺ conditions. Importantly, the increase in renal oxygen supply maintained cortical P_{O₂} in the normal Na⁺ group and increased it in the low Na⁺ group to levels similar to the baseline normal Na⁺ group, restoring the cortico-medullary gradient. The diverse acute effects on renal oxygen metabolism in response to angiotensin II AT₁ receptor blockade between normal and low Na⁺ fed animals may also be, to some extent, associated with morphological changes in the outer medulla (Stillman *et al.* 1994) or with increased angiotensin II availability for activation of AT₂ receptors.

Similar to what was observed during angiotensin II receptor blockade, aldosterone mineralocorticoid receptor blockade did not alter MAP or GFR, compared with baseline in both diets. However, although RBF and oxygen delivery were not altered in both diets after mineralocorticoid blockade, \dot{Q}_{O_2} and fractional oxygen extraction were reduced, along with significantly increases in FE_{Na} in the low Na⁺ group compared with respective baselines, with no effect on renal P_{O₂}. This suggested that aldosterone mineralocorticoid receptor activation is in part responsible for higher low Na⁺-induced \dot{Q}_{O_2} in the kidney. Indeed, aldosterone mineralocorticoid receptor activation in connecting and collecting duct is of major importance for Na⁺ conservation during a low Na⁺ diet, as eliminating it will result in Na⁺ waste in mice (Ronzaud *et al.* 2007). Plasma aldosterone increases in Na⁺ depleted rats after 7 days, along with ENaC activity (Frindt *et al.* 2018), which is in good agreement with the hypothesis that a low Na⁺ diet shifts Na⁺ reabsorption to less effective sections of the tubule, with the higher energy requirements to reabsorb Na⁺ resulting in higher \dot{Q}_{O_2} , as presently observed.

High Na⁺ is generally associated with increased blood pressure and a higher risk for cardiovascular disease (Intersalt Cooperative Research Group, 1988; Mente *et al.* 2014). Accordingly, in hypertensive individuals in whom reducing Na⁺ intake results in reduced blood pressure, cardiovascular health benefits are achieved (Cook *et al.* 2007; Adler *et al.* 2014). However, the debate on how much Na⁺ should be removed from the diet and the ideal Na⁺ intake is still on-going (Cook *et al.* 2020). Indeed, although high Na⁺ intake has been demonstrated in numerous studies to have negative cardio-renal effects, drastically reducing Na⁺ intake is also somewhat surprisingly associated with a worse outcome (Intersalt Cooperative Research Group, 1988; Midgley *et al.* 1996; Stolarz-Skrzypek *et al.* 2011; Graudal *et al.* 2014; Mente *et al.* 2014; O'Donnell *et al.* 2014; Adamovich *et al.* 2017). The association of Na⁺ intake and mortality seems to have a U-shaped curve, with both low and high Na⁺ diets leading to increased cardiovascular events and mortality. However, it cannot be excluded that the increased risk observed in the low Na⁺ diet participants may be influenced by pre-existing comorbidities such as diabetes and history of cardiovascular disease (O'Donnell *et al.* 2014), which requires further investigation. While the adverse effects of high Na⁺ intake seem to be due to blood pressure effects, the increased risk associated with low Na⁺ intake was unaffected by adjustment for blood pressure, suggesting blood pressure independent mechanisms (O'Donnell *et al.* 2014). Hence, a reduction in Na⁺ intake resulting in lower arterial blood pressure has clear beneficial cardiovascular effects, but a profound further reduction of Na⁺ intake beyond this point is associated with increased cardiovascular events. In the

present study, a 90% decrease in Na⁺ intake increased kidney \dot{Q}_{O_2} and induced cortical hypoxia, which could provide an explanation for why, in some cases, reducing Na⁺ intake without concomitantly reducing arterial blood pressure is associated with poor outcomes.

In conclusion, the present study demonstrates that low Na⁺ intake in normotensive conditions is associated with RAAS activation and increased kidney \dot{Q}_{O_2} and cortical hypoxia. Furthermore, a low Na⁺ diet-induced increase in \dot{Q}_{O_2} is mainly associated with increased aldosterone-mediated Na⁺ transport. Given the present results, in the absence of high blood pressure, dietary Na⁺ restriction needs to be carefully monitored, as it may be detrimental for the kidney. Future experiments are necessary to elucidate the mechanisms operating. An in-depth study of the angiotensin (1-7)-Mas receptor axis on oxygen metabolism following a low Na⁺ diet is highly relevant in this context. Moreover, longitudinal studies to follow renal function and P_{O_2} , along with blood pressure, during dietary Na⁺ reduction will expand our understanding of its effects over time.

References

- Adamovich Y, Ladeux B, Golik M, Koeners MP & Asher G (2017). Rhythmic oxygen levels reset circadian clocks through HIF1 α . *Cell Metab* **25**, 93–101.
- Adler AJ, Taylor F, Martin N, Gottlieb S, Taylor RS & Ebrahim S (2014). Reduced dietary salt for the prevention of cardiovascular disease. *Cochrane Database Syst Rev* **2014**, Cd009217.
- Banday AA & Lokhandwala MF (2011). Angiotensin II-mediated biphasic regulation of proximal tubular Na⁺/H⁺ exchanger 3 is impaired during oxidative stress. *Am J Physiol Renal Physiol* **301**, F364–F370.
- Brezis M, Agmon Y & Epstein FH. (1994a). Determinants of intrarenal oxygenation. I. Effects of diuretics. *Am J Physiol Renal Physiol* **267**, F1059–F1062.
- Brezis M, Heyman SN & Epstein FH (1994b). Determinants of intrarenal oxygenation. II. Hemodynamic effects. *Am J Physiol Renal Physiol* **267**, F1063–F1068.
- Brezis M, Rosen S, Silva P & Epstein FH (1984). Renal ischemia: a new perspective. *Kidney Int* **26**, 375–383.
- Chen X, Li W, Yoshida H, Tsuchida S, Nishimura H, Takemoto F, Okubo S, Fogo A, Matsusaka T & Ichikawa I (1997). Targeting deletion of angiotensin type 1B receptor gene in the mouse. *Am J Physiol Renal Physiol* **272**, F299–F304.
- Cohen JJ (1986). Relationship between energy requirements for Na⁺ reabsorption and other renal functions. *Kidney Int* **29**, 32–40.
- Committee on the Consequences of Sodium Reduction in Populations; Food and Nutrition Board; Board on Population Health and Public Health Practice; Institute of Medicine (2013). In *Sodium Intake in Populations: Assessment of Evidence*, eds Strom BL, Yaktine AL & Oria M. The National Academy of Sciences, Washington, DC, USA.
- Cook NR, Cutler JA, Obarzanek E, Buring JE, Rexrode KM, Kumanyika SK, Appel LJ & Whelton PK (2007). Long term effects of dietary sodium reduction on cardiovascular disease outcomes: observational follow-up of the trials of hypertension prevention (TOHP). *BMJ* **334**, 885–888.
- Cook NR, He FJ, MacGregor GA & Graudal N (2020). Sodium and health-concordance and controversy. *BMJ* **369**, m2440–m2440.
- Emans TW, Janssen BJ, Pinkham MI, Ow CP, Evans RG, Joles JA, Malpas SC, Krediet CT & Koeners MP (2016). Exogenous and endogenous angiotensin-II decrease renal cortical oxygen tension in conscious rats by limiting renal blood flow. *J Physiol* **594**, 6287–6300.
- Emans TW, Patinha D, Joles JA, Koeners MP, Janssen BJ & Krediet CTP (2018). Angiotensin II-induced hypertension in rats is only transiently accompanied by lower renal oxygenation. *Sci Rep* **8**, 16342.
- Fox J, Guan S, Hymel AA & Navar LG (1992). Dietary Na and ACE inhibition effects on renal tissue angiotensin I and II and ACE activity in rats. *Am J Physiol Renal Physiol* **262**, F902–F909.
- Franzen S, Pihl L, Khan N, Gustafsson H & Palm F (2016). Pronounced kidney hypoxia precedes albuminuria in type 1 diabetic mice. *Am J Physiol Renal Physiol* **310**, F807–F809.
- Friederich-Persson M, Persson P, Fasching A, Hansell P, Nordquist L & Palm F (2013). Increased kidney metabolism as a pathway to kidney tissue hypoxia and damage: effects of triiodothyronine and dinitrophenol in normoglycemic rats. *Adv Exp Med Biol* **789**, 9–14.
- Frindt G, Yang L, Bamberg K & Palmer LG (2018). Na restriction activates ENaC in rat kidney through two mechanisms and decreases distal Na delivery. *J Physiol* **596**, 3585–3602.
- Garty H (2000). Regulation of the epithelial Na⁺ channel by aldosterone: open questions and emerging answers. *Kidney Int* **57**, 1270–1276.
- Geibel J, Giebisch G & Boron WF (1990). Angiotensin II stimulates both Na⁺-H⁺ exchange and Na⁺/HCO₃⁻ cotransport in the rabbit proximal tubule. *Proc Natl Acad Sci U S A* **87**, 7917–7920.
- Graudal N, Jurgens G, Baslund B & Alderman MH (2014). Compared with usual sodium intake, low- and excessive-sodium diets are associated with increased mortality: a meta-analysis. *Am J Hypertens* **27**, 1129–1137.
- Graudal NA, Galloe AM & Garred P (1998). Effects of sodium restriction on blood pressure, renin, aldosterone, catecholamines, cholesterol, and triglyceride: a meta-analysis. *JAMA* **279**, 1383–1391.
- Hirakawa Y, Tanaka T & Nangaku M (2017). Renal hypoxia in CKD; pathophysiology and detecting methods. *Front Physiol* **8**, 99.
- Insko EW, Imig JD & Cook AK (1997). Afferent and efferent arteriolar vasoconstriction to angiotensin II and norepinephrine involves release of Ca²⁺ from intracellular stores. *Hypertension* **29**, 222–227.

- Intersalt Cooperative Research Group (1988). Intersalt: an international study of electrolyte excretion and blood pressure. Results for 24 hour urinary sodium and potassium excretion. Intersalt Cooperative Research Group. *BMJ* **297**, 319–328.
- Källskog O, Lindbrom LO, Ulfendahl HR & Wolgast M (1976). Hydrostatic pressures within the vascular structures of the rat kidney. *Pflugers Arch* **363**, 205–210.
- Kitami Y, Okura T, Marumoto K, Wakamiya R & Hiwada K (1992). Differential gene expression and regulation of type-1 angiotensin II receptor subtypes in the rat. *Biochem Biophys Res Commun* **188**, 446–452.
- Kobori H, Nangaku M, Navar LG & Nishiyama A (2007). The intrarenal renin-angiotensin system: from physiology to the pathobiology of hypertension and kidney disease. *Pharmacol Rev* **59**, 251–287.
- Kong YW, Baqar S, Jerums G & Ekinci EI (2016). Sodium and its role in cardiovascular disease – the debate continues. *Front Endocrinol* **7**, 164.
- Körner A, Eklöf AC, Celsi G & Aperia A (1994). Increased renal metabolism in diabetes: mechanism and functional implications. *Diabetes* **43**, 629–633.
- Layton AT, Laghmani K, Vallon V & Edwards A (2016). Solute transport and oxygen consumption along the nephrons: effects of Na⁺ transport inhibitors. *Am J Physiol Renal Physiol* **311**, F1217–F1229.
- Lelli D, Antonelli-Incalzi R, Bandinelli S, Ferrucci L & Pedone C (2018). Association between sodium excretion and cardiovascular disease and mortality in the elderly: a cohort study. *J Am Med Dir Assoc* **19**, 229–234.
- Leong PK, Devillez A, Sandberg MB, Yang LE, Yip DK, Klein JB & McDonough AA. (2006). Effects of ACE inhibition on proximal tubule sodium transport. *Am J Physiol Renal Physiol* **290**, F854–F863.
- Manotham K, Tanaka T, Matsumoto M, Ohse T, Miyata T, Inagi R, Kurokawa K, Fujita T & Nangaku M (2004). Evidence of tubular hypoxia in the early phase in the remnant kidney model. *J Am Soc Nephrol* **15**, 1277–1288.
- Matsumoto M, Tanaka T, Yamamoto T, Noiri E, Miyata T, Inagi R, Fujita T & Nangaku M (2004). Hypoperfusion of peritubular capillaries induces chronic hypoxia before progression of tubulointerstitial injury in a progressive model of rat glomerulonephritis. *J Am Soc Nephrol* **15**, 1574–1581.
- Mente A, O'Donnell MJ, Rangarajan S, McQueen MJ, Poirier P, Wielgosz A, Morrison H, Li W, Wang X, Di C, Mony P, Devanath A, Rosengren A, Oguz A, Zatonska K, Yusufali AH, Lopez-Jaramillo P, Avezum A, Ismail N, Lanas F, Puoane T, Diaz R, Kelishadi R, Iqbal R, Yusuf R, Chifamba J, Khatib R, Teo K & Yusuf S (2014). Association of urinary sodium and potassium excretion with blood pressure. *N Engl J Med* **371**, 601–611.
- Midgley JP, Matthew AG, Greenwood CM & Logan AG (1996). Effect of reduced dietary sodium on blood pressure: a meta-analysis of randomized controlled trials. *JAMA* **275**, 1590–1597.
- Miyata K, Rahman M, Shokoji T, Nagai Y, Zhang GX, Sun GP, Kimura S, Yukimura T, Kiyomoto H, Kohno M, Abe Y & Nishiyama A (2005). Aldosterone stimulates reactive oxygen species production through activation of NADPH oxidase in rat mesangial cells. *J Am Soc Nephrol* **16**, 2906–2912.
- O'Donnell M, Mente A, Rangarajan S, McQueen MJ, Wang X, Liu L, Yan H, Lee SF, Mony P, Devanath A, Rosengren A, Lopez-Jaramillo P, Diaz R, Avezum A, Lanas F, Yusuf K, Iqbal R, Ilow R, Mohammadifard N, Gulec S, Yusufali AH, Kruger L, Yusuf R, Chifamba J, Kabali C, Dagenais G, Lear SA, Teo K & Yusuf S (2014). Urinary sodium and potassium excretion, mortality, and cardiovascular events. *N Engl J Med* **371**, 612–623.
- O'Neill J, Corbett A & Johns EJ (2013). Dietary sodium intake modulates renal excretory responses to intrarenal angiotensin (1–7) administration in anesthetized rats. *Am J Physiol Regul Integr Comp Physiol* **304**, R260–R266.
- O'Neill J, Fasching A, Pihl L, Patinha D, Franzen S & Palm F (2015). Acute SGLT inhibition normalizes O₂ tension in the renal cortex but causes hypoxia in the renal medulla in anaesthetized control and diabetic rats. *Am J Physiol Renal Physiol* **309**, F227–F234.
- O'Neill J, Healy V & Johns EJ (2017). Intrarenal Mas and AT₁ receptors play a role in mediating the excretory actions of renal interstitial angiotensin-(1-7) infusion in anaesthetized rats. *Exp Physiol* **102**, 1700–1715.
- Oliverio MI, Best CF, Smithies O & Coffman TM (2000). Regulation of sodium balance and blood pressure by the AT_{1A} receptor for angiotensin II. *Hypertension* **35**, 550–554.
- Onozato ML, Tojo A, Goto A, Fujita T & Wilcox CS (2002). Oxidative stress and nitric oxide synthase in rat diabetic nephropathy: effects of ACEI and ARB. *Kidney Int* **61**, 186–194.
- Ow CP, Abdelkader A, Hilliard LM, Phillips JK & Evans RG (2014). Determinants of renal tissue hypoxia in a rat model of polycystic kidney disease. *Am J Physiol Regul Integr Comp Physiol* **307**, R1207–R1215.
- Palm F, Cederberg J, Hansell P, Liss P & Carlsson PO (2003). Reactive oxygen species cause diabetes-induced decrease in renal oxygen tension. *Diabetologia* **46**, 1153–1160.
- Palm F, Hansell P, Ronquist G, Waldenstrom A, Liss P & Carlsson PO (2004). Polyol-pathway-dependent disturbances in renal medullary metabolism in experimental insulin-deficient diabetes mellitus in rats. *Diabetologia* **47**, 1223–1231.
- Palmer LG & Schnermann J (2015). Integrated control of Na transport along the nephron. *Clin J Am Soc Nephrol* **10**, 676–687.
- Patinha D, Fasching A, Pinho D, Albino-Teixeira A, Morato M & Palm F (2013). Angiotensin II contributes to glomerular hyperfiltration in diabetic rats independently of adenosine type I receptors. *Am J Physiol Renal Physiol* **304**, F614–F622.
- Pei L, Solis G, Nguyen MT, Kamat N, Magenheimer L, Zhuo M, Li J, Curry J, McDonough AA, Fields TA, Welch WJ & Yu AS (2016). Paracellular epithelial sodium transport maximizes energy efficiency in the kidney. *J Clin Invest* **126**, 2509–2518.

- Peti-Peterdi J, Warnock DG & Bell PD (2002). Angiotensin II directly stimulates ENaC activity in the cortical collecting duct via AT(1) receptors. *J Am Soc Nephrol* **13**, 1131–1135.
- Pruijm M, Hofmann L, Maillard M, Tremblay S, Glatz N, Wuerzner G, Burnier M & Vogt B (2010). Effect of sodium loading/depletion on renal oxygenation in young normotensive and hypertensive men. *Hypertension* **55**, 1116–1122.
- Ronzaud C, Loffing J, Bleich M, Gretz N, Grone HJ, Schutz G & Berger S (2007). Impairment of sodium balance in mice deficient in renal principal cell mineralocorticoid receptor. *J Am Soc Nephrol* **18**, 1679–1687.
- Schmid C, Castrop H, Reitbauer J, Bruna RD & Kurtz A. (1997). Dietary salt intake modulates angiotensin II type 1 receptor gene expression. *Hypertension* **29**, 923–929.
- Shao W, Seth DM, Prieto MC, Kobori H & Navar LG (2013). Activation of the renin-angiotensin system by a low-salt diet does not augment intratubular angiotensinogen and angiotensin II in rats. *Am J Physiol Renal Physiol* **304**, F505–F514.
- Stillman IE, Brezis M, Heyman SN, Epstein FH, Spokes K & Rosen S (1994). Effects of salt depletion on the kidney: changes in medullary oxygenation and thick ascending limb size. *J Am Soc Nephrol* **4**, 1538–1545.
- Stolarz-Skrzyppek K, Kuznetsova T, Thijs L, Tikhonoff V, Seidlerova J, Richart T, Jin Y, Olszanecka A, Malyutina S, Casiglia E, Filipovsky J, Kawecka-Jaszcz K, Nikitin Y & Staessen JA (2011). Fatal and nonfatal outcomes, incidence of hypertension, and blood pressure changes in relation to urinary sodium excretion. *JAMA* **305**, 1777–1785.
- Udwan K, Abed A, Roth I, Dizin E, Maillard M, Bettoni C, Loffing J, Wagner CA, Edwards A & Feraille E (2017). Dietary sodium induces a redistribution of the tubular metabolic workload. *J Physiol* **595**, 6905–6922.
- Welch WJ, Baumgartl H, Lubbers D & Wilcox CS (2001). Nephron pO₂ and renal oxygen usage in the hypertensive rat kidney. *Kidney Int* **59**, 230–237.
- Welch WJ, Baumgärtl H, Lübbers D & Wilcox CS (2003). Renal oxygenation defects in the spontaneously hypertensive rat: role of AT1 receptors. *Kidney Int* **63**, 202–208.
- Welch WJ, Blau J, Xie H, Chabrashvili T & Wilcox CS (2005). Angiotensin-induced defects in renal oxygenation: role of oxidative stress. *Am J Physiol Heart Circ Physiol* **288**, H22–H28.
- Yingst DR, Massey KJ, Rossi NF, Mohanty MJ & Mattingly RR (2004). Angiotensin II directly stimulates activity and alters the phosphorylation of Na-K-ATPase in rat proximal tubule with a rapid time course. *Am J Physiol Renal Physiol* **287**, F713–F721.
- Zhou H, Yang M, Jiang Z, Ding J, Di J & Cui L (2018). Renal hypoxia: an important prognostic marker in patients with chronic kidney disease. *Am J Nephrol* **48**, 46–55.

Additional information

Data availability statement

The data that support the findings of this study are available online in the Supporting information section.

Competing interests

The authors declare that they have no competing interests.

Author contributions

D.P. and F.P. conceived and designed the work; D.P., C.C., P.P., L.P., J.O. and A.F. conducted the acquisition of data; D.P. performed analysis and D.P., C.C. and M. P.-F. interpretation of data for the work; D.P. and C.C. drafted the article; D.P., C.C., P.P., A.F., L.P., M.P.-F., J.O. and F.P. revised and approved the final version. All authors agree to be accountable for all aspects of the work. All persons designated as authors qualify for authorship, and all those who qualify for authorship are listed.

Funding

This work was supported by the Swedish Research Council, the Swedish Diabetes Foundation, the Swedish Heart-Lung Foundation, the Family Ernforss Fund, the British Heart Foundation (FS/14/2/30630 and PG/15/68/31717) and the European Union, Seventh Framework Programme, Marie Curie Actions (CARPEDIEM - No 612280).

Keywords

aldosterone, angiotensin II, hypoxia, kidney, low Na⁺, oxygen consumption

Supporting information

Additional supporting information may be found online in the Supporting Information section at the end of the article.

Statistical Summary Document